



description

The UVB-100 increases your productivity by pumping out water vapor in vacuum systems more quickly, giving you more time for additional vacuum process runs or other tasks each day. It is ideal for O-ring sealed vacuum chambers in high humidity environments.

The UVB-100 system applies UVC radiation to the inside of vacuum chambers, which results in faster desorption of water vapor and decreased pump-down times. The system comprises the control (with key-lock mechanism), HV- and UHV-compatible UV emitter, and cables.

The emitter can be inserted into any available 2-3/4" flange. The emitter can also be adapted to other flange sizes.

This graph displays a typical pump-down time with and without the UVB-100.

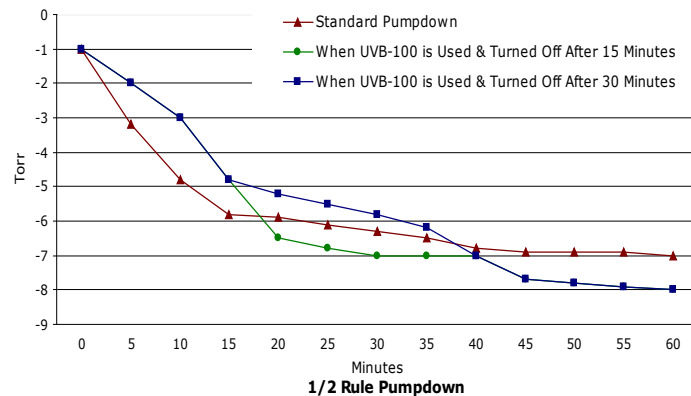

benefits

Easy to Use: Simply turn it on; no cables need to be removed and no blankets are necessary.

Efficient: Water is desorbed more quickly so that you can get your work done sooner.

Compatible: Ideal for large chambers and load locks with O-ring seals. Works with most HV and UHV systems.

UV water desorption system

UVB-100

specifications

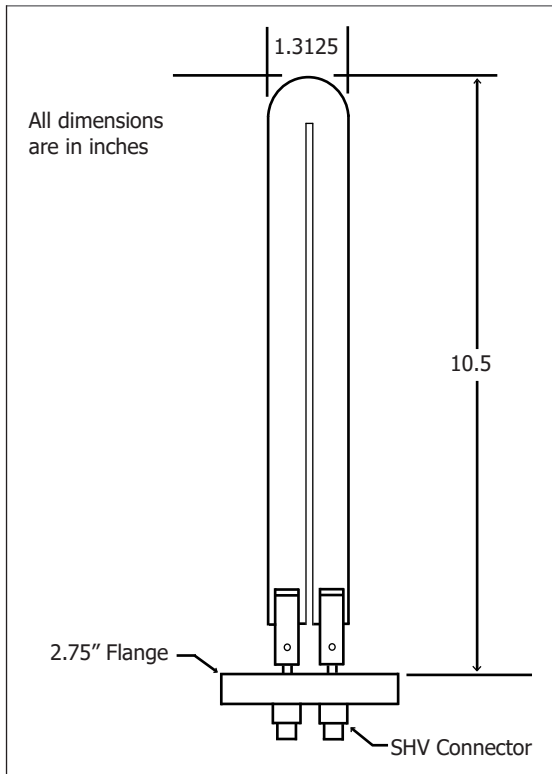

Control Unit

Power	90 to 250 VAC, 50 Hz/60 Hz Input Line
Timer Function	Up to 99 hours 59 minutes
Remote Operation	Back Panel Remote Input: 12, 24, 120, 240 VAC 12, 24, 48, 100 VDC
Emitter Hour Meter	Will count up to 99,999.9 hours. Reset button sets counter to 0.
Dimensions	19" rack mount x 12" deep x 3" high

UV Emitter

Power	20 watts (5 watts UVC) standard.
Flange-to-end of emitter distance	Minimum of 1/4" required between end of emitter and any surface.
Width of emitter	Emitter is 34 mm wide. 35 mm ID tube required.
Lifetime	Lifetime is typically > than 5000 hours.
Radiant Bakeout Temp.	200° C

options

Flange Options	Can be UHV or HV flange-mounted; custom vacuum system mounting is available
Shutter-Operated Shroud	Available option for deposition system applications
UV Shield	For systems with quartz windows
Adaptor Nipple	Provides the best configuration for your system. Contact RBD for your specific requirements.

special safety features

- Keyed power switch that acts as a lock-out for when the system is up to air
- UV "On" indicator as a reminder that the UVB-100 is in use

All specifications are subject to change without notice.



2437 NE Twin Knolls Drive • Suite 2 • Bend, Oregon • 97701
Phone: 541.330.0723 • Fax: 541.330.0991
email: sales@rbdinstruments.com • web: www.rbdinstruments.com